

sanwa



PC5000a

DIGITAL MULTIMETER

INSTRUCTION MANUAL



CONTENTS

[1] SAFETY PRECAUTIONS

1-1	Explanation of Warning Symbols	1
1-2	Warning Instruction for Safe Use	1
1-3	Overload protections	2

[2] APPLICATION AND FEATURES

2-1	Applications	3
2-2	Features	3

[3] NAME OF FUNCTIONS

3-1	Multimeter and Test Leads	4
3-2	Display	5

[4] DESCRIPTION OF FUNCTIONS

4-1	Function Switch	6
4-2	Auto Power Off	6
4-3	Low Battery Indication	6
4-4	Measurement Function Select	6
4-5	Range Hold	7
4-6	Data Hold	7
4-7	Set Beeper Off	7
4-8	RS232C Interface	7
4-9	Max/Min Recording Mode	8
4-10	Max/Min Capture Mode (Peak hold)	8
4-11	500000 count	8
4-12	Relative Mode	8
4-13	Words	9

[5] MEASUREMENT PROCEDURE

5-1	Start-Up Inspection	11
5-2	Voltage Measurement	12
5-3	Line Frequency Measurement	16
5-4	Logic Frequency / Duty Ratio measurement	18
5-5	Testing Diode/ Resistance Measurement and Checking Continuity / Capacitance Measurement.....	19
5-6	Current / %4-20mA Measurement	23
5-7	How to use Optional Products	27

[6] MAINTENANCE

6-1	Maintenance and Inspection	31
6-2	Calibration	31
6-3	Battery and Fuse Replacement	31
6-4	Storage	32

[7] AFTER-SALE SERVICE

7-1	Warranty and Provision	33
7-2	Repair	33
7-3	SANWA web site	34

[8] SPECIFICATIONS

8-1	General Specifications	35
8-2	Measurement Range and Accuracy	37

[1] SAFETY PRECAUTIONS

***Before use, read the following safety precautions.**

This instruction manual explains how to use your new digital multimeter PC5000a safely. Before use, please read this manual thoroughly, and keep it together with the product for your reference. The instruction given under the heading "⚠️WARNING" must be followed to prevent accidental burn or electrical shock.

1-1 Explanation of Warning Symbols

The meaning of the Symbols used in this manual and attached to the product are explained as follows.

⚠️: Very important instruction for safe use.

The warning messages are intended to prevent accidents such as burn and electrical shock to operating personnel.

The caution messages are intended to prevent damage to the instrument.

⚠️: Dangerous voltage (Take care not to get an electric shock in voltage measurement.)

⏚: Ground (Allowable applied voltage range between the input terminal and earth.)

—: Direct current (DC)

~: Alternating current (AC)

⚡: Fuse

⏚: Double insulation (Protection Class II)

1-2 Warning Instruction for Safe Use

⚠️ WARNING

To ensure that the meter is used safely, be sure to observe the instruction when using the instrument.

1. Never use meter on the electric circuit that exceed 6kVA.
2. Never apply an input signal exceeding the maximum rating input value.
3. Never use meter if the meter or test leads are damaged or broken.
4. Pay special attention when measuring the voltage of AC 33 Vrms (46.7V peak) or DC 70V and over avoid injury.
5. Never use meter for measuring the line connected with equipment (i.e. motors) that generates induced or surge voltage since it may exceed the maximum allowable voltage.
6. Never use uncased meter.

7. Be sure to use a fuse of the specified rating or type. Never use a substitute of the fuse or never make a short circuit of the fuse.
8. When connecting and disconnecting the test leads, connect the ground lead (black one) first. When disconnecting them, the ground lead must be disconnected last.
9. Always keep your fingers below the finger guards on the probe when making measurements.
10. Be sure to disconnect the test pins from the circuit when changing the function.
11. Before starting measurement, make sure that the function and range are properly set in accordance with the measurement.
12. Never use meter with wet hands or in a damp environment.
13. Do not use the device near an item of strong electromagnetic generation or a charged item.
14. Never open tester case except when replacing batteries or fuse. Do not attempt any alteration of original specifications.
15. To ensure safety and maintain accuracy, calibrate and check the tester at least once a year.
16. The multimeter is restricted to indoor use only.

 **CAUTION**

Correct measurement may not be performed when using the meter in the ferromagnetic / intense electric field such as places near a transformer, a high-current circuit, and a radio.

1-3 Overload protections

Functions	Input terminals	Maximum rating input value	Maximum overload protection input
mV	mV•V• Ω • •)) • • → • • - COM	DC•AC 500mV	600VDC/VAC rms
V		DC•AC 1000V	1050V rms, 1450Vpeak
Ω • •)) • • → • • -	COM	 Voltage and Current input prohibited	600VDC/VAC rms
Hz		Peak max : 900V	1000VDC/VAC rms
μA•mA	μA•mA COM	DC•AC 500mA	0.63A/500V Fuse IR 200kA
A	A COM	DC•AC 10A*	12.5A/500V Fuse IR 20kA

*<6A: Continuous measurement is possible. >6A: Cool down DMM for 3 minutes after the measurement for 1 minute.

[2] APPLICATION AND FEATURES

2-1 Applications

This instrument is portable digital multimeter designed for measurement of weak current circuits. It plays an important role in circuitry analysis by using additional functions as well as measurements of small type communication equipment, electrical home appliance, lighting voltage and batteries of various type.

2-2 Features

- The instrument meets the requirements to Safety Standard IEC 61010.
- The main unit case and the circuit board are made of fire retarding materials.
- Fuse protects the current function.
- 500,000 counts in DCV and 999,999 counts in Hz range
- Fast Response Digit: 5 times/sec., Bargraph: 60 times /sec.
- Frequency measurement with 5 selectable sensitivity (Sine RMS)
- Capacitance measurement ranges are 50.00nF to 9999 μ F.
- dBm, Duty ratio, %4-20mA measurement
- 0.01 Ω of resistance and 0.01mV of AC/DC resolution
- AC coupling True RMS / AC+DC coupling True RMS
- MAX/MIN Recording through Auto range
- MAX/MIN Capture (Peak hold 0.8ms in duration) through Auto range
- Relative measurement through Auto range
- RS-232C interface

[3] NAME OF FUNCTIONS

3-1 Multimeter and Test Leads

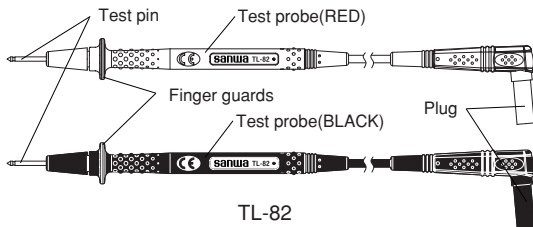
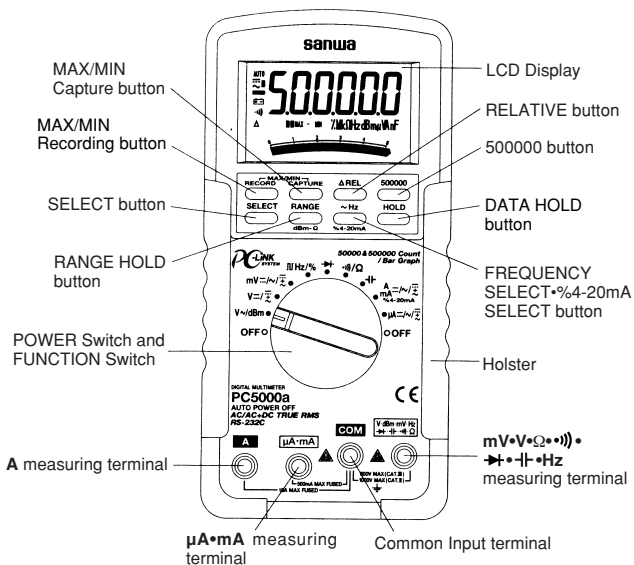

3-2 Display

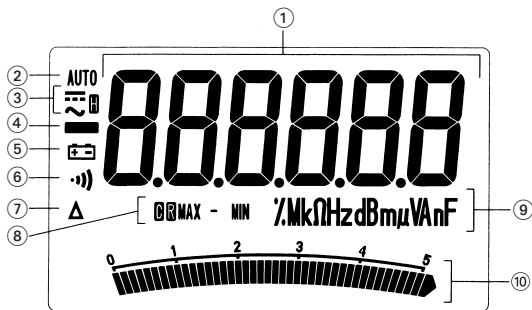

- ① Display value in the main display area
- ② Auto range display
- ③ : Data hold display
 : DC measurement display
 : AC measurement display
- ④ Minus polarity for numeral data
- ⑤ Battery discharge warning display
- ⑥ Checking continuity display
- ⑦ Relative measurement function display
- ⑧ : Capture mode display
 : Record mode display
 MAX: Maximum value display
 MIN: Minimum value display
- ⑨ Measurement unit display
- ⑩ Analog bargraph

[4] DESCRIPTION OF FUNCTIONS

4-1 Function Switch

Turn this switch to turn on and off the power and to select the functions of "V~•dBm/V $\overline{\text{---}}$ /mV/ $\overline{\text{Hz}}$ •%/ $\overline{\text{---}}$ / $\overline{\text{---}}$ /A•mA/ $\overline{\mu\text{A}}$ ".

4-2 Auto Power Off

The Auto Power Off mode turns the meter off automatically to extend battery life after approximately 17 minutes of no activities. Activities are specified as:

- 1) Changing sw position or pressing a button.
- 2) Significant measuring data readings of around 10% of range.

To wake up the meter from Auto Power Off:

Press the **RECORD, CAPTURE, Δ REL** or **500000** button momentarily. Alternatively, disconnect the measured subject from the DMM temporarily, set the rotary switch to the OFF position, then set it back on the measurement target item, and connect the measurement subject again.

To disable the Auto Power Off feature, press the **RANGE** button while turning the function switch on.

Note:

Always turn the function switch to the OFF position when the meter is not in use.

4-3 Low Battery Indication

If the internal battery has been consumed and the internal battery drops below approx. 7V, Battery mark is shown in the display.

4-4 Measurement Function Select

When the **SELECT** button is pressed (\rightarrow), the functions change as follows.

- In the case of **V~ / dBm**, the modes change as:
V~ \rightarrow dBm \rightarrow V~.
- In the case of **V $\overline{\text{---}}$ / $\overline{\text{---}}$** , the modes change as:
V $\overline{\text{---}}$ \rightarrow V $\overline{\text{---}}$ \rightarrow V $\overline{\text{---}}$.
- In the case of **mV $\overline{\text{---}}$ / \sim / $\overline{\text{---}}$** , the modes change as:
 $\overline{\text{---}}$ \rightarrow \sim \rightarrow $\overline{\text{---}}$ \rightarrow $\overline{\text{---}}$.
- In the case of **$\overline{\text{Hz}}$ / %**, the modes change as:
 $\overline{\text{Hz}}$ \rightarrow % \rightarrow $\overline{\text{Hz}}$.

- In the case of $\Omega/\bullet||)$, the modes change as:
 $\bullet||) \rightarrow \Omega \rightarrow \bullet||)$.
- In the case of $\mu A, mA$ and A , the modes change as:
 $\dots \rightarrow \sim \rightarrow \ddot{x} \rightarrow \dots$.

4-5 Range Hold

Press the **RANGE** button momentarily to set the manual range mode then 'AUTO' disappears in the display. In manual range mode, press the button again to step through the ranges. To return to the auto mode, press the button for 1 sec. or more then AUTO is shown.

Note:

Manual mode is not available in Hz measurement.

4-6 Data Hold

When the **HOLD** button is pressed, the data display at that time is hold ('**H**' is shown on the display). The display will not changed while the function is active. Press the button again to cancel the function. ('**H**' on the display disappears.)

4-7 Set Beeper Off

Press the **HZ** button while turning the function switch on to disable the Beeper feature.

However continuity and mis-insertion alarm function remain.

4-8 RS232C Interface

The instrument equips with an optical isolated interface port at the back of meter body for data communication. Optional accessories KB-RS2a (RS232 cable), KB-USB2a (USB cable) and PC Link or PC Link Plus (software), are required for Data logging system. Refer to an help in the PC Link or PC Link Plus for further details.

4-9 Max/Min Recording Mode

Press the RECORD button momentarily to activate MAX/MIN recording mode then 'R' and 'MAX MIN' are shown. The instrument beeps when new maximum or minimum reading is updated. Press the button momentarily to read throughout the Maximum ('MAX'), Minimum ('MIN'), and Maximum minus Minimum ('MAX-MIN') readings. Press the RECORD button for 1 second or more to exit the Recording mode. Auto Power Off feature will be disabled automatically in this mode.

4-10 Max/Min Capture Mode (Peak hold)

Press the CAPTURE button momentarily to activate Capture (Instantaneous peak hold) mode to capture voltage or current signal duration as short as 5ms. 'C' and 'MAX' are shown in the display. This mode is available in DCV, ACV, DCA and ACA functions. The instrument beeps when new maximum or minimum reading is updated. Press the button momentarily to read throughout the Maximum (MAX), Minimum (MIN), and Maximum minus Minimum (MAX-MIN) readings. Press the CAPTURE button for 1 second or more to exit the Capture Mode. Auto Power Off feature will be disabled automatically in this mode.

4-11 500000 count

In DCV, DCmV and Hz function, press "500000" button momentarily to toggle between 50000 count and 500000 readings.

In 50000, counts sampling rate is 5 times per sec. In 500000 counts, sampling rate is 1.25 times per sec.

4-12 Relative Mode

Selecting Relative mode causes the meter to zero the display and store the present reading as a reference value.

Practically all-displaying readings can be set as relative reference value including MAX/MIN Recording Mode. Press the Δ REL button momentarily to activate and to exit Relative Mode.

Relative function can not be used with dBm function.

4-13 Words

Analog Bargraph

The analog bargraph provides a visual indication of measurement like a traditional analog meter needle.

AC coupling True RMS



When measurement is taken by true r.m.s., the measurement value of input signal becomes the scales of the signal power and therefore provide more effective values than those obtained by average value detection. This multimeter employs this true RMS circuit, which enables measurement of sine wave and non-sinusoidal waves like square wave and triangular wave in r.m.s.

AC+DC coupling True RMS

DC+AC True RMS calculates both of the AC and DC components given by the expression $\sqrt{DC^2+(AC\ rms)^2}$ when making measurement, and can respond accurately to the total effective RMS value regardless of the waveform.

Crest Factor

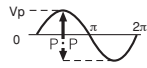
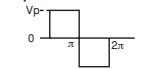
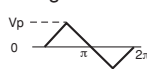
The crest factor (CF) is expressed by a value obtained by dividing the peak value of the signal by its RMS value. Most common waveforms such as sine wave and triangular wave have a relatively cycle have a high crest factor. The voltages and crest factors of typical waveforms are shown in the table.

Input Waveform	Peak V_p	RMS V_{rms}	Average V_{avg}	CF V_p/V_{rms}	Form Factor V_{rms}/V_{avg}
Sine Wave 	$V_{rms} \cdot \sqrt{2}$	$\frac{V_p}{\sqrt{2}}$	$\frac{2V_p}{\pi}$	$\sqrt{2}$	$\frac{\pi}{2\sqrt{2}}$
	=1.414 V_{rms}	=0.707 V_p	=0.637 V_p	=1.414	=1.111
Square Wave 	V_p	V_p	V_p	1	1
Triangular Wave 	$V_{rms} \cdot \sqrt{3}$	$\frac{V_p}{\sqrt{3}}$	$\frac{V_p}{2}$	$\sqrt{3}$	$\frac{2}{\sqrt{3}}$
	=1.732 V_{rms}	=0.577 V_p	=0.5 V_p	=1.732	=1.155
Puls 	V_p	$\sqrt{\frac{\tau}{2\pi}} \cdot V_p$	$\frac{\tau}{2\pi} \cdot V_p$	$\sqrt{\frac{2\pi}{\tau}}$	$\sqrt{\frac{2\pi}{\tau}}$

Please note the measurement should be taken at the crest factor below 5.

NMRR (Normal Mode Rejection Ratio)

NMRR is the DMM's ability to reject unwanted AC noise effect, which causes inaccurate DC measurements. NMRR is typically specified in terms of dB (decibel). This series has a NMRR specification of >60dB at 50 and 60Hz, which means a good ability to reject the effect of AC noise in DC measurements.

CMRR (Common Mode Rejection Ratio)

Common mode voltage is voltage present on both the COM and VOLTAGE input terminals of a DMM, with respect to ground. CMRR is the DMM's ability to reject common mode voltage effect, which causes digit rattle or offset in voltage measurements. The CMRR function of this meter is activated at >90 dB at DC to 60 Hz with the ACV measuring function, and at >120 dB at DC or 50/60 Hz with the DCV measuring function.

[5] MEASUREMENT PROCEDURE

5-1 Start-Up Inspection

⚠ WARNING

1. Never use meter if the meter or test leads are damaged or broken.
2. Make sure that the test leads are not cut or otherwise damaged.

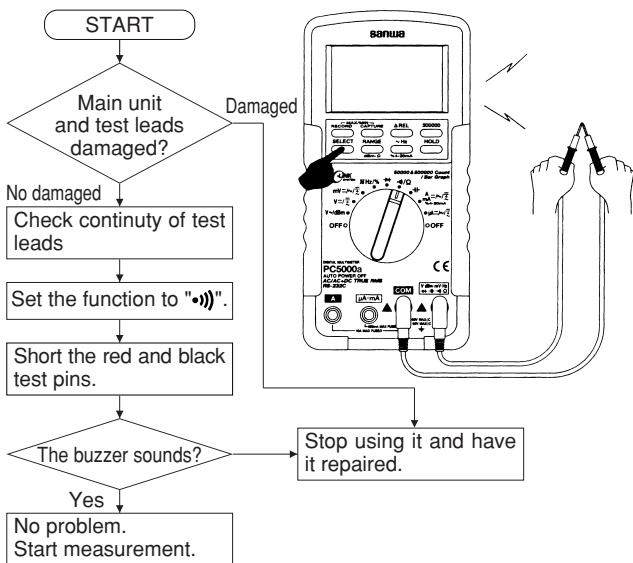

5-2 Voltage Measurement

WARNING

1. Never apply an input signal exceeding the maximum rating input value.
2. Be sure to disconnect the test pins from the circuit when changing the function.
3. Always keep your fingers behind the finger guards on the probe when making measurements.

DCmV: Maximum rating input value 500mVDC

DCV: Maximum rating input value 1000VDC

ACmV: Maximum rating input value 500mVAC

ACV: Maximum rating input value 1000VAC

(AC+DC)mV: Maximum rating input value 500mVAC/DC

(AC+DC)V: Maximum rating input value 1000VAC/DC

5-2-1 ACV / dBm measurement

1) Applications

ACV: Sine wave AC voltage such as lighting voltage is measured.

dBm: The decibel is measured.

2) Measuring ranges

4 ranges from 5.0000V to 1000.0V

-11.76dBm to 54.25dBm at 600Ω

3) Measurement procedure

- ① Connect the plug of black test lead to **COM** terminal and plug of red test lead to **V** or **dBm** terminal.
- ② Set the function switch to '**V~** / **dBm**'.
- ③ Press "**SELECT**" button to between '**V~**' and '**dBm**' measurement.
- ④ Apply the red and black test pins to the circuit to measure.
- ⑤ The reading of Voltage is shown in the display.
- ⑥ After measurement, release the red and black test pins from the object measured.

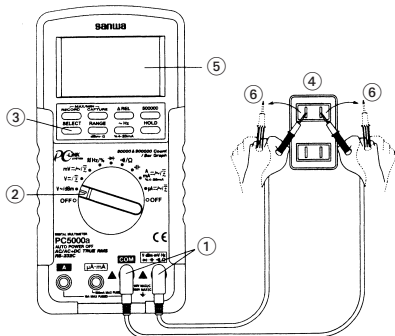

Note:

Power-up-default reference impedance will be displayed for 1 second before displaying the dBm readings. Press **dBm-Ω(RANGE)** button momentarily to select different reference impedance of 4, 8, 16, 32, 50, 75, 93, 110, 125, 135, 150, 200, 250, 300, 500, 600, 800, 900, 1000, up to 1200Ω. The new impedance value will be saved automatically to the non-volatile memory as power up default.

5-2-2 DCV / (AC+DC) V measurement

1) Applications

DCV: Voltage of the battery and DC circuit are measured.

(AC+DC)V: Voltage of the AC component+DC component is measured.

2) Measuring ranges

4 ranges from 5.0000V to 1000.0V

3) Measurement procedure

- ① Connect the plug of black test lead to **COM** terminal and plug of red test lead to **V** terminal.
- ② Set the function switch to 'V $\overline{\text{---}}$ ' or 'V $\overline{\text{AC}}$ '
- ③ Press "**SELECT**" button to button ' $\overline{\text{---}}$ ' or ' $\overline{\text{AC}}$ ' measurement.
- ④ Apply the red and black test pins to the circuit to measure.
 - For measurement of DCV, apply the black test pin to the negative potential side of the circuit to measure and the red test pin to the positive potential side.
 - For measurement of (AC+DC)V, apply the red and black test pins to the circuit to measure.
- ⑤ The reading of Voltage is shown in the display.
- ⑥ After measurement, release the red and black test pins from the object measured.

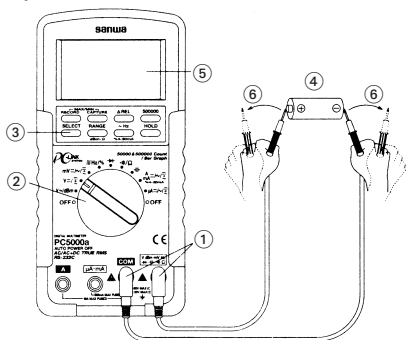

Note:

Press "**500000**" button to toggle 50000 count and 500000 count at DCV.

5-2-3 ACmV / DCmV / (AC+DC) mV measurement

1) Applications

ACmV: Voltage of the battery and DC circuit are measured.

DCmV: Voltage of the DC circuit is measured.

(AC+DC) mV: Voltage of the AC component+DC component is measured.

2) Measuring ranges

1 ranges 500.00mV

3) Measurement procedure

- ① Connect the plug of black test lead to **COM** terminal and plug of red test lead to **mV** terminal.
- ② Set the function switch to 'mV'.
- ③ Press "**SELECT**" button to toggle '⎓' or '∼' or '⎓' measurement.
- ④ Apply the red and black test pins to the circuit to measure.
 - For measurement of DCmV, apply the black test pin to the negative potential side of the circuit to measure and the red test pin to the positive potential side.
 - For measurement of ACmV, apply the red and black test pins to the circuit to measure.
 - For measurement of (AC+DC)mV, apply the red and black test pins to the circuit to measure.
- ⑤ The reading of Voltage is shown in the display.
- ⑥ After measurement, release the red and black test pins from the object measured.

Note:

Press "**500000**" button to between 50000 count and 500000 count at DCmV.

5-3 Line Frequency Measurement

⚠ WARNING

1. Never apply an input signal exceeding the maximum rating input value.
2. Be sure to disconnect the test pins from the circuit when changing the function.
3. Always keep your fingers behind the finger guards on the probe when making measurements.

1) Application

Frequency of an AC circuit is measured.

2) Measuring ranges

10Hz to 200.00kHz (Auto range)

3) Measurement procedure

- ① Connect the plug of black test lead to **COM** measuring input terminal and plug of red test lead to **Hz** measuring terminal.
- ② Set the function switch to '**mV**' or '**V**' or '**μA**' or '**mA**' or '**A**'.
- ③ Press the "**~ Hz**" button momentarily to activate or to exit Hz.
- ④ Apply the red and black test pins to an object to measure.
- ⑤ Read the value in the display.
- ⑥ After measurement, release the red and black test pins from the object measured.

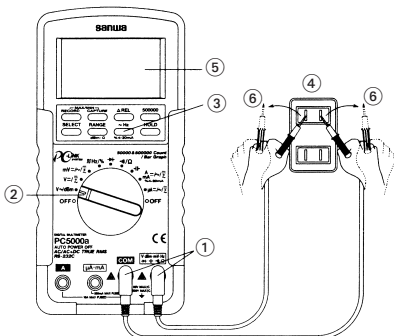

Note:

Press "**500000**" button to between 50000 count and 500000 count.

Frequency measurement is available at '**mV**' or '**V**' or '**μA**' or '**mA**' or '**A**' functions.

V RANGE	Sensitivity (Sine RMS)	Measurement Range
500mV	0.1V min	10.000Hz ~ 200.00kHz
5V	1V min	
50V	10V min	10.000Hz ~ 100.00kHz
500V	100V min	
1000V	900V min	10.000Hz ~ 10.000kHz

Input sensitivity varies automatically with function range selected before activating the Hz function. mV function has the highest (100mV) and the 1000V range has the lowest (900V). It is recommended to first measure the signal voltage (or current) level then activates the Hz function in that voltage (or current) range to automatically set the most appropriate trigger level.

To select another trigger level manually, press the RANGE button momentarily. If the Hz reading becomes unstable, select lower sensitivity to avoid electrical noise. If the reading shows zero, select higher sensitivity.

5-4 Logic Frequency / Duty Ratio measurement

⚠ WARNING

1. Never apply an input signal exceeding the maximum rating input value.
2. Be sure to disconnect the test pins from the circuit when changing the function.
3. Always keep your fingers behind the finger guards on the probe when making measurements.
4. The square waveform of a negative voltage cannot be measured.

1) Application

Logic Frequency: Logic frequency is measured.

Duty ratio: Duty ratio is measured.

2) Measuring ranges

Logic Frequency: 5.0000Hz to 2.0000MHz (Auto range)

Duty ratio: 0.1% to 99% (Auto range)

3) Measurement procedure

- ① Connect the plug of black test lead to **COM** measuring input terminal and plug of red test lead to **Hz** measuring terminal.
- ② Set the function switch to '**Hz/%**'.
- ③ Press "**SELECT**" button to toggle between **Hz** and **%** (duty ratio).
- ④ Apply the red and black test pins to an object to measure.
- ⑤ Read the value in the display.
- ⑥ After measurement, release the red and black test pins from the object measured.

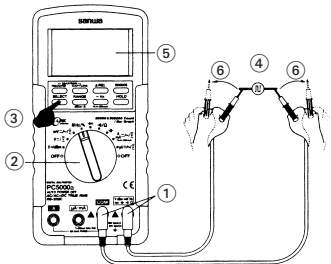

Note:

No bargraph in Hz and duty cycle function.

Press "**500000**" button to between 50000 count and 500000 count at Hz.

Input sensitivity is set only at the highest.

5-5 Testing Diode/ Resistance Measurement and Checking Continuity / Capacitance Measurement

⚠ WARNING

Never apply voltage to the input terminals.

5-5-1 Testing Diode

1) Application

The quality of diodes is tested.

2) How to use

- ① Connect the plug of black test lead to **COM** measuring input terminal and plug of red test lead to **▶** measuring terminal.
- ② Set the function switch to '**▶**'.
- ③ Apply the black test pins to the cathode of the diode and the red test pin to the anode.
 - ✓ Check reading for judgment of good or defective.
 - A zero reading indicates a shorted diode (defective).
 - An OL indicates an open diode (defective).
- ④ Apply the red test pins to the cathode of the diode and the black test pin to the anode.
 - ✓ Check reading for judgment of good or defective.
 - The display shows OL, if diode is good. Any other readings indicated the diode is resistive or shorted (defective).
- ⑤ After measurement, release the red and black test pins from the object measured.

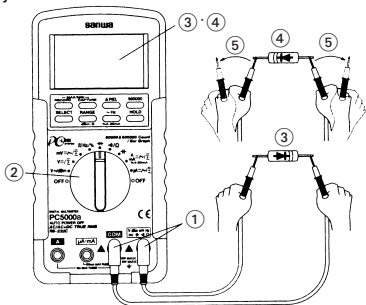

Note:

Release voltage of the input terminals is about <3.5V.

5-5-2 Resistance Measurement

⚠ CAUTION

The reading may vary because of external inductance when measuring high resistance value.

- 1) Applications
Resistance of resistors and circuits is measured.
- 2) Measuring ranges
6 ranges from 500.00Ω to 50.000MΩ.
- 3) Measurement procedure
 - ① Connect the plug of black test lead to **COM** input terminal and plug of red test lead to Ω input terminal.
 - ② Set the function switch to 'Ω/•)' and select 'Ω' by pressing the "**SELECT**" button.
 - ③ Apply the red and black test pins to an object to measure.
 - ④ The reading is shown in the display.
 - ⑤ After measurement, release the red and black test pins from the object measured.

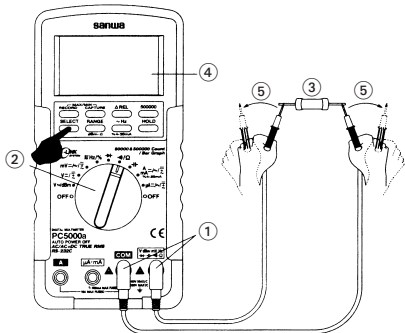

Note:

To compensate internal and lead resistance for low ohm measurement, use Relative function.

If measurement is likely to be influenced by noise, shield the object to measure with negative potential (COM).

If a finger touches a test pin during measurement, measurement will be influenced by the resistance in the human body and result in measurement error.

Release voltage of the input terminals is about <1.3VDC.
(<3VDC for 500Ω range)

5-5-3 Checking Continuity

1) Application

Checking the continuity of wiring and selecting wires.

2) How to use

- ① Connect the plug of black test lead to **COM** measuring input terminal and plug of red test lead to **•|)** measuring terminal.
- ② Set the function switch to '**Ω•|)**' and select '**•|)**' by pressing "**SELECT**" button.
- ③ Apply the red and black test pins to a circuit or conductor to measure.
- ④ The continuity can be judged by whether the buzzer sounds or not.
- ⑤ After measurement, release the red and black test pins from the object measured.

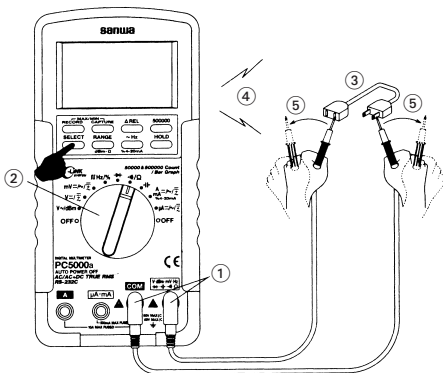

Note:

Threshold: between 20Ω and 120Ω.

Response time: <100μs

5-5-4 Capacitance Measurement



CAUTION

Discharge the capacitance before measurement.

- 1) Application
Measures capacitance of condenser.
- 2) Measuring ranges
6 ranges from 50.00nF to 9999 μ F
- 3) Measurement procedure
 - ① Connect the plug of black test lead to **COM** measuring input terminal and plug of red test lead to **⎓** measuring terminal.
 - ② Set the function switch to '**⎓**'.
 - ③ Apply the red and black test pins to an object to measure.
 - ④ Read the value on the display.
 - ⑤ After measurement, release the red and black test pins from the object measured.

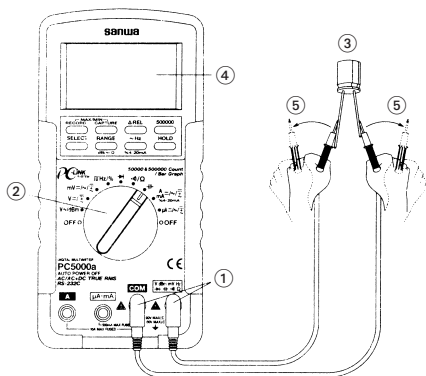

Note:

While data communication to PC, Capacitance can be measured up to 500.0 μ F range because of low response speed for large capacitance measurement.

5-6 Current / %4-20mA Measurement

⚠ WARNING

1. Never apply voltage to the input terminals.
2. Be sure to make a series connection via load.
3. When measuring 3-phase system, special attention should be paid to the phase-to-phase voltage which is significantly higher than the phase to earth voltage.
4. Do not apply an input exceeding the maximum rated current to the input terminals.
5. Before starting measurement, turn OFF the power switch of the circuit to separate the measuring part, and connect the test leads firmly.

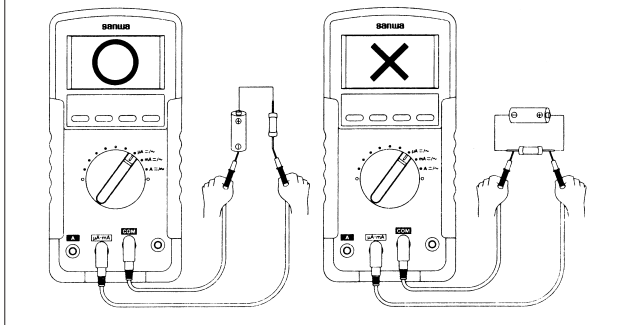

5-6-1 Current Measurement: 10A

DCA: Maximum rating input value 10ADC

ACA: Maximum rating input value 10AAC

(AC+DC)A: Maximum rating input value 10A AC/DC

- 1) Applications
DCA: Current in batteries and DC circuits is measured.
ACA: Current in AC circuits is measured.
- 2) Measuring ranges
2 ranges for 5.000A, 10.00A

3) Measurement procedure

- ① Connect the plug of black test lead to COM measuring input terminal, and plug of red test lead to A measuring terminal.
- ② Set the function switch to 'A' and select either '—' or '~' or '⎓' by pressing the "SELECT" switch.
- ③ In the circuit to measure, apply the red and black test pins in series with load.
 - For measurement of DCA, apply the black test pin to the negative potential side of the circuit to measure, and the red test pin to the positive potential side in series with load.
 - For measurement of ACA, apply the red and black test pins to the circuit to measure in series with load.
 - For measurement of (AC+DC)A, apply the red and black test pins to the circuit to measure in series with load.
- ④ Apply the red and black test pins to the circuit to measure.
- ⑤ Read the value on the display.
- ⑥ After measurement, remove the red and black test pins from the circuit measured.

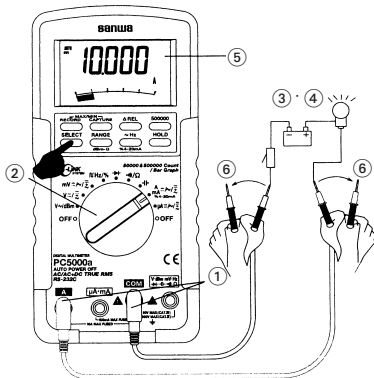

Note:

<6A: Continuous measurement is possible. >6A: Cool down DMM for 3 minutes after the measurement for 1 minute.

5-6-2 Current Measurement: μA , mA

DC μA , mA : Maximum rating input value 500mADC

AC μA , mA : Maximum rating input value 500mAAC

(AC+DC) μA , mA : Maximum rating input value 500mA AC/DC

1) Applications

DCA: Current in batteries and DC circuits is measured.

ACA: Current in AC circuits is measured.

(AC+DC)A: Current in AC component + DC component is measured.

2) Measuring ranges

4 ranges for 500.00 μA /5000.0 μA and 50.000mA/500.00mA

3) Measurement procedure

- ① Connect the plug of black test lead to **COM** measuring input terminal, and plug of red test lead to **$\mu\text{A}/\text{mA}$** measuring terminal.
- ② Set the function switch to ' **μA** ' or ' **mA** ' and select either '---', '~' or '⌘' by pressing the "**SELECT**" button.
- ③ In the circuit to measure, apply the red and black test pins in series with load.
 - For measurement of μA and mA , apply the black test pin to the negative potential side of the circuit to measure and the red test pin to the positive potential side in series with load.
 - For measurement of μA and mA , apply the red and black test pins to the circuit to measure in series with load.
 - For measurement of (AC+DC) μA and mA , apply the red and black test pins to the circuit to measure in series with load.
- ④ Apply the red and black test pins to the circuit to measure.
- ⑤ In DcmA function, press and hold "**%4-20mA**" button for 1 second or more to display the current digital data in terms of loop current percentage (%) value.
- ⑥ Read the value on the display.
- ⑦ After measurement, remove the red and black test pins from the circuit measured.

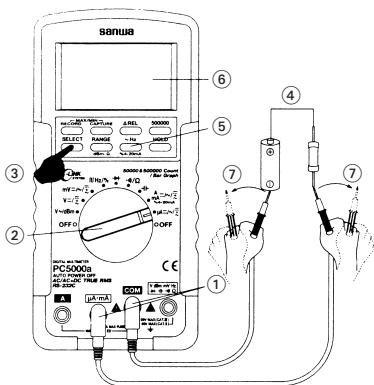

Note:

In %4-20mA function, it is set at 4mA = 0% and 20mA + 100%.

5-7 How to use Optional Products

WARNING

1. Never apply an input signal exceeding the maximum rating input value of optional products.
2. Be sure to disconnect the test pins from the circuit when changing the function.

5-7-1 Clamp probe: CL-20D

1) Applications

It is suitable for measurement of alternating current in electric equipment and power supplies.

2) Measuring ranges

2 ranges for 20A, 200A

3) Measurement procedure

- ① Connect the black plug to **COM** measuring terminal, and the red plug to **V** measuring terminal.
- ② Set the function to '**V~**'.
- ③ Press the "**RANGE**" button to hold the 5V range.
- ④ Select either 20A or 200A with selector knob of clamp meter.
- ⑤ Open the clamp part, have electric wire (one line) clamped, and close the clamp part completely.
- ⑥ Read the value on the display. *1
- ⑦ After measurement, open the clamp part, and release clamp probe from the electric wire.

*1: Read the value on the display as follows

Measuring range	Multiplier	Unit
20A	x10	A
200A	x100	A

* The effective digits indication is "0.000".

5-7-2 Clamp probe: CL-22AD

1) Applications

ACA: It is suitable for measurement of alternating current in electric equipment and power supplies.

DCA: An electric current of electric circuit of a car, and a consumption electric current of direct current apparatus are measured.

2) Measuring ranges

ACA: 2 ranges for 20A, 200A

DCA: 2 ranges for 20A, 200A

3) Measurement procedure

- ① Connect the black plug to **COM** measuring terminal, and the red plug to **V** measuring terminal.
- ② Set the function to '**V**' or '**V**'.
- ③ Press the "**RANGE**" button to hold the 5V range.
- ④ Select either 20A or 200A by selector knob of clamp meter.
 - The zero point varies when the DCA is measured, so be sure to check that the multimeter indicates zero. If not zero, adjust the indication to the zero point by turning the Zero adjuster (0ADJ).
- ⑤ Open the clamp part, have electric wire (one line) clamped, and close the clamp part completely.
- ⑥ Read the value on the display. *2
- ⑦ After measurement, open the clamp part, and release clamp probe from the electric wire.

*2: Read the value on the display as follows

Measuring range	Multiplier	Unit
20A	x100	A
200A	x1000	A

* Please do not use it in 500,000 counts.

* The effective digits indication is "0.000".

5-7-3 Clamp probe: CL33DC

1) Applications

An electric current of electric circuit of a car and a consumption electric current of direct current apparatus are measured.

2) Measuring ranges

2 ranges for 30A, 300A

3) Measurement procedure

- ① Connect the black plug to **COM** measuring terminal, and the red plug to **V** measuring terminal.
- ② Set the function to 'V $\overline{\text{---}}$ '.
- ③ Press the "**RANGE**" button to hold the 5V range.
- ④ Select either 30A or 300A with selector knob of clamp meter.
 - The zero point varies when the DCA is measured, so be sure to check that the multimeter indicates zero. If not zero, adjust the indication to the zero point by turning the Zero adjuster (0ADJ).
- ⑤ Open the clamp part, have electric wire (one line) clamped, and close the clamp part completely.
- ⑥ Read the value on the display. *3
- ⑦ After measurement, open the clamp part, and release clamp probe from the electric wire.

*3: Read the value on the display as follows

Measuring range	Multiplier	Unit
30A	x100	A
300A	x1000	A

* Please do not use it in 500,000 counts.

* The effective digits indication is "0.000".

5-7-4 Temperature probe: T300-PC

1) Applications

To measure temperature from -50 °C to 300 °C.

2) Measuring ranges

Range of -50°C to 30°C

3) Measurement procedure

- ① Connect the black plug to **COM** measuring terminal and the red plug to Ω measuring terminal.
- ② Set the function to ' Ω/\bullet)' and select ' Ω ' by pressing the "**SELECT**" button.
- ③ Press the "**RANGE**" button to hold the 5k Ω range.
- ④ Apply the sensor to an object to measure.
- ⑤ Read the value on the display. *4
- ⑥ After measurement, release the sensor from the object measured.

*4: The value on the display of DMM shows a resistance value indicate. Please read the value of measuring window of PC Link.

[6] MAINTENANCE

WARNING

1. This section is very important for safety. Read and understand the following instruction fully and maintain your instrument properly.
2. The instrument must be calibrated and inspected at least once a year to maintain the safety and accuracy.

6-1 Maintenance and Inspection

- 1) Appearance
 - Is the appearance not damaged by falling, etc?
- 2) Test leads
 - Is the cord of the test leads not damaged?
 - Is the core wire not exposed at any place of the test leads?

NOTE:

If the built-in fuse is blown, only the current measurement does not work.

Make sure that the test leads are not cut, referring to the section 5-1.

6-2 Calibration

The manufacturer may conduct the calibration and inspection. For more information, please contact the manufacturer.

6-3 Battery and Fuse Replacement

WARNING

1. If the rear case or the battery lid is removed when any input is applied to the input terminals, you may get electrical shock. Before starting the work, always make sure that no input is applied.
2. Before starting the work, be sure to turn OFF the main power and release the test leads from the circuit.
3. Be sure to use a fuse of the specified rating or type. Never use a substitute of the fuse or never make a short circuit of the fuse.

Factory-preinstalled built-in battery

A battery for monitoring is preinstalled before shipping, therefore it may run down sooner than the battery life specified in the instruction manual.

The "battery for monitoring" is a battery to inspect the functions and specifications of the product.

- ① Remove the battery lid screw by a screwdriver.
- ② Removed the battery lid.
- ③ Take out the battery or fuse, and replace it with a new one.
- ④ Attach the battery lid and fix it by the screwdriver.

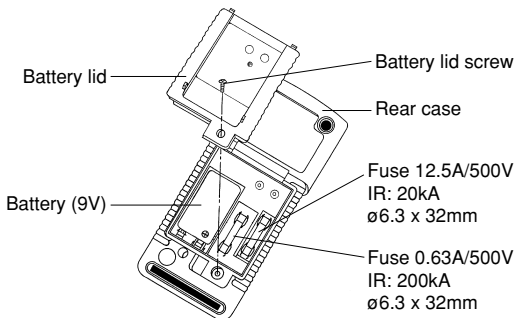

⚠ **CAUTION**

Set a battery carefully being sure to observe the correct polarities.

6-4 Storage

⚠ **CAUTION**

1. The panel and the case are not resistant to volatile solvent and must not be cleaned by thinner or alcohol. For cleaning, use dry, soft cloth and wipe it lightly.
2. The panel and the case are not resistant to heat. Do not place the instrument near heat-generating devices (such as a soldering iron).
3. Do not store the instrument in a place where it may be subjected to vibration or from where it may fall.
4. For storing the instrument, avoid hot, cold or humid places or places under direct sunlight or where condensation is anticipated.

Following the above instructions, store the instrument in good environment. (See 8-1)

[7] AFTER-SALE SERVICE

7-1 Warranty and Provision

Sanwa offers comprehensive warranty services to its end-users and to its product resellers. Under Sanwa's general warranty policy, each instrument is warranted to be free from defects in workmanship or material under normal use for the period of one (1) year from the date of purchase.

This warranty policy is valid within the country of purchase only, and applied only to the product purchased from Sanwa authorized agent or distributor.

Sanwa reserves the right to inspect all warranty claims to determine the extent to which the warranty policy shall apply.

This warranty shall not apply to fuses, disposables batteries, or any product or parts, which have been subject to one of the following causes:

1. A failure due to improper handling or use that deviates from the instruction manual.
2. A failure due to inadequate repair or modification by people other than Sanwa service personnel.
3. A failure due to causes not attributable to this product such as fire, flood and other natural disaster.
4. Non-operation due to a discharged battery.
5. A failure or damage due to transportation, relocation or dropping after the purchase.

7-2 Repair

Customers are asked to provide the following information when requesting services:

1. Customer name, address, and contact information
2. Description of problem
3. Description of product configuration
4. Model Number
5. Product Serial Number
6. Proof of Date-of-Purchase
7. Where you purchased the product

- 1) Prior to requesting repair, please check the following:
Capacity of the built-in battery, polarity of installation and discontinuity of the test leads.
- 2) Repair during the warranty period:
The failed meter will be repaired in accordance with the conditions stipulated in 7-1 Warranty and Provision.
- 3) Repair after the warranty period has expired:
In some cases, repair and transportation cost may become higher than the price of the product. Please contact Sanwa authorized agent / service provider in advance.
The minimum retention period of service functional parts is 6 years after the discontinuation of manufacture. This retention period is the repair warranty period. Please note, however, if such functional parts become unavailable for reasons of discontinuation of manufacture, etc., the retention period may become shorter accordingly.
- 4) Precautions when sending the product to be repaired
To ensure the safety of the product during transportation, place the product in a box that is larger than the product 5 times or more in volume and fill cushion materials fully and then clearly mark "Repair Product Enclosed" on the box surface. The cost of sending and returning the product shall be borne by the customer.

7-3 SANWA web site

<http://www.sanwa-meter.co.jp>

E-mail: exp_sales@sanwa-meter.co.jp

[8] SPECIFICATIONS

8-1 General Specifications

Display:

4-4/5 digits 50000 counts LCD display (selectable 5-4/5 digits
500000 counts for DCV and 999999 counts for Hz)

Update Sampling Rate:

4-4/5 Digital data: 5 times / sec nominal

5-4/5 Digital data: 1.25 times / sec nominal

52 segments bar graph: 60 times / sec nominal

Low Battery Indication:

Below approx. 7V

Operating Temperature and Humidity:

0°C to 30°C, 0-80% RH; 31°C to 50°C, 0-50% RH No condensation

Storage Temperature/Humidity Range:

-20°C to 60°C, 80% RH MAX. No condensation

Altitude:

Operating below 2000m

Temperature Coefficient:

Nominal 0.15x(specified accuracy)/ °C @(0°C -18°C or 28°C -50°C),
or otherwise specified

Power Supply:

Single alkaline 9V battery; NEDA1604A, IEC6LF22 or 6LR61

Sensing:

AC, AC+DC True RMS

Auto Power Off Timing:

Idle for 17 minutes

Safety:

IEC61010-1(EN61010-1) 2nd (2001)

V/ \rightarrow / Ω / \bullet)/ \rightarrow /Hz : CAT III for 600V DC & AC, and CAT II for
1kV DC & AC

μ A•mA : CAT II 500V AC & 300V DC

A : CAT II 500V AC & 300V DC

Transient Protection:

6.5kV (1.2/50 μ s surge)

Pollution degree:

2

E.M.C.:

Meets EN61326-1: 2006

Power Consumption:

42mW Typical/0.6mW Typical (Auto Power off)

Dimension:

179(H) x 87(W) x 55(D) mm with holster

Weight:

320 g, 460 g with holster

Accessories:

Test leads (TL-82), Alligator clip (CL-13), Holster (H-50),
Instruction manual

Optional Accessories:

RS232 cable: KB-RS2

Software: PC Link, PC Link Plus

Temperature Probe: T-300PC (Platinic thin film)

Clamp Probe: CL-20D, CL-22AD, and CL33DC

OVERVOLTAGE CATEGORY

- **Equipment of CAT I** is equipment for connection to circuits in which measures are taken to limit the transient overvoltages to an appropriate low level.
Note: Examples include protected electronic circuits.
- **Equipment of CAT II** is energy-consuming equipment to be supplied from the fixed installation.
Note: Examples include household, office, and laboratory appliances.
- **Equipment of CAT III** is equipment in fixed installations.
Note: Examples include switches in the fixed installation and some equipment for industrial use with permanent connection to the fixed installation.
- **Equipment of CAT IV** is for use at the origin of the installation.
Note: Examples include electricity meters and primary over-current protection equipment.

8-2 Measurement Range and Accuracy

Accuracy assurance range: $23 \pm 5^{\circ}\text{C}$, 75%RH MAX. No condensation.

True RMS voltage & current accuracies are specified from 5% to 100% of range or otherwise specified. Maximum crest factor <5:1 at full scale & <10:1 at half scale, and with frequency components within the specified frequency bandwidth for non-sinusoidal waveforms.

DC Voltage

RANGE	Accuracy*
500.00mV, 5.0000V, 50.000V	0.03%rdg + 2dgt
500.00V	0.05%rdg + 2dgt
1000.0V	0.1%rdg + 2dgt

NMRR:>90dB @ 50/60Hz

CMRR:>120dB @ DC or 50/60 Hz, unbalanced resistance $1\text{k}\Omega$

Input Impedance: $10\text{M}\Omega$, 30pF nominal (80pF nominal for 500mV range)

*500,000 counts accuracy: (Accuracy of a range)%rdg + 20dgt

AC & AC+DC Voltage

RANGE	Accuracy*
45Hz - 300Hz	
500.00mV, 5.0000V, 50.000V, 500.00V, 1000.0V	0.8%rdg + 60dgt
300Hz - 1kHz	
500.00mV	0.8%rdg + 40dgt
5.0000V, 50.000V, 500.00V	2.0%rdg + 60dgt
1000.0V	1.0%rdg + 40dgt
1kHz - 20kHz	
500.00mV	$\pm 1\text{dB}^{**}$
5.0000V, 50.000V	$\pm 2\text{dB}^{**}$
500.00V	$\pm 3\text{dB}^{**}$
1000.0V	Unspec'd

*From 5% to 10% of range: Accuracy % of reading + 80digit

**From 5% to 10% of range: Accuracy % of reading + 180digit

**From 10% to 15% of range: Accuracy % of reading + 100digit

CMRR:>90dB @ DC to 60Hz, $R_s=1\text{k}\Omega$

Input Impedance: $10\text{M}\Omega$, 30pF nominal (80pF nominal for 500mV range) Residual reading less than 50 digits with test leads shorted.

dBm

At 600Ω , -11.76dBm to 54.25dBm,

Accuracy: $\pm 0.25\text{dB} + 2\text{dgt}$ (@40Hz - 20kHz)

Input Impedance: $10\text{M}\Omega$, 30pF nominal

Selectable reference impedance of 4, 8, 16, 32, 50, 75, 93, 110, 125, 135, 150, 200, 250, 300, 500, 600, 800, 900, 1000, 1200Ω

DC Current

RANGE	Accuracy	Internal Resistance
500.00 μ A	0.15%rdg + 20dgt	Approx. 100 Ω
5000.0 μ A	0.1%rdg + 20dgt	
50.000mA	0.15%rdg + 10dgt	Approx. 1 Ω
500.00mA	0.1%rdg + 20dgt	
5.0000A	0.5%rdg + 10dgt	Approx. 0.005 Ω
10.000A*	0.5%rdg + 20dgt	

*<6A: Continuous measurement is possible. >6A: Cool down DMM for 3 minutes after the measurement for 1 minute.

AC & AC+DC Current

RANGE	Accuracy	Internal Resistance
50Hz ~ 60Hz		
500.00 μ A	1.0%rdg \pm 40dgt	Approx. 100 Ω
5000.0 μ A		
50.000mA		Approx. 1 Ω
500.00mA		
5.0000A		Approx. 0.005 Ω
10.000A*		
40Hz ~ 1KHz		
500.00 μ A	1.0%rdg + 40dgt	Approx. 100 Ω
5000.0 μ A		
50.000mA		Approx. 1 Ω
500.00mA		
5.0000A		Approx. 0.005 Ω
10.000A*		

*<6A: Continuous measurement is possible. >6A: Cool down DMM for 3 minutes after the measurement for 1 minute.

DC Loop Current %4~20mA

Accuracy: \pm 25dgt

4mA = 0% (zero) 20mA = 100% (span) Resolution: 0.01%

Ω Ohms

RANGE	Accuracy
500.00Ω	0.2%rdg + 6dgt
5.0000kΩ	
50.000kΩ	
500.00kΩ	
5.0000MΩ	0.8%rdg + 6dgt
50.000MΩ	2.0%rdg + 6dgt

Open Circuit Voltage : <1.3VDC (<3VDC for 500Ω range)

⊞ Capacitance

RANGE	Accuracy*
50.00nF	0.8%rdg + 3dgt
500.0nF	
5.000μF	1.0%rdg + 3dgt
50.00μF	2.0%rdg + 3dgt
500.0μF	3.5%rdg + 5dgt
9999μF	5.0%rdg + 5dgt

Measurement range of 500.0 μF manual range: 50.0 to 500.0 μF.

Measurement range of 9999μF manual range: 500 to 9999μF.

*Accuracies with film capacitor or better

~ Hz Line Level Frequency

V RANGE	Sensitivity (Sine RMS)	Measurement Range
500mV	0.1V min	10.000Hz ~ 200.00kHz
5V	1V min	
50V	10V min	10.000Hz ~ 100.00kHz
500V	100V min	
1000V	900V min	10.000Hz ~ 10.000kHz

Accuracy: 0.02%rdg + 4dgt

]] Hz Logic Level Frequency

RANGE	Accuracy
5.000Hz~2.0000MHz	0.002%rdg + 4dgt

Sensitivity: 2.5Vp square wave

%Duty Ratio

RANGE	Accuracy
0.1% - 99.99%	3dgt/kHz + 2dgt

Input Frequency: 5Hz - 500 kHz, 5V Logic Family

→ Diode Test

Range	Accuracy	Test Current (Typical)	Open Circuit Voltage
2.0000V	1%rdg + 1dgt	0.4mA	<3.5 VDC

•)) Audible Continuity Tester

Audible threshold: between 20Ω and 200Ω Response time < 100μs

Capture mode (Instantaneous Peak Hold) CAPTURE

Accuracy: Specified accuracy ±200 digits for changes > 0.8ms in duration

※Do not use the tester near places where strong electromagnetic waves and trance are generated or strong electrical voltages are generated.

Specifications and external appearance of the product described above may be revised for modification without prior notice.

sanwa

**SANWA ELECTRIC
INSTRUMENT CO.,LTD.**

Dempa Bldg, Sotokanda2-Chome
Chiyoda-Ku, Tokyo, Japan

TEL: 81-3-3253-4871 / FAX: 81-3-3256-9740

Web site: <http://www.sanwa-meter.co.jp>

E-mail: exp_sales@sanwa-meter.co.jp